

Round 3 Sunday, May 10, 2026

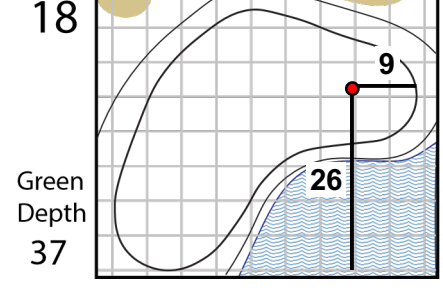

The Woodlands Country Club
Tournament Course

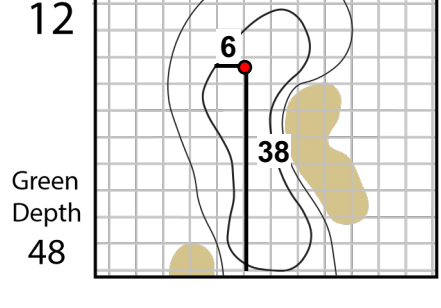
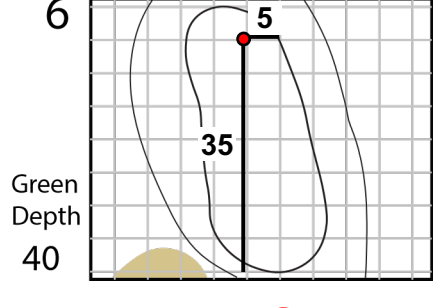
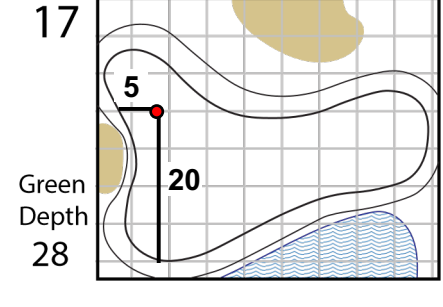
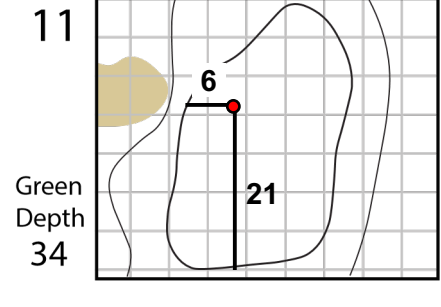
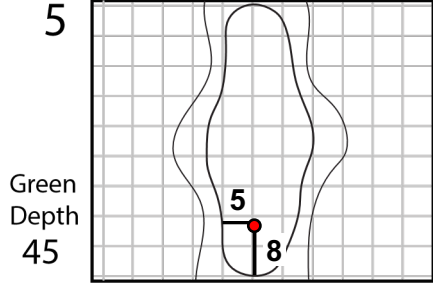
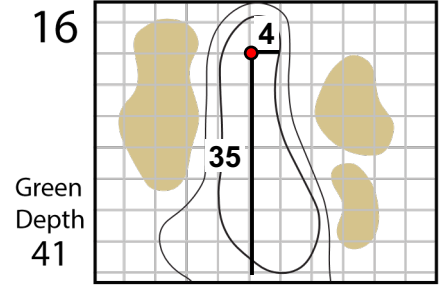
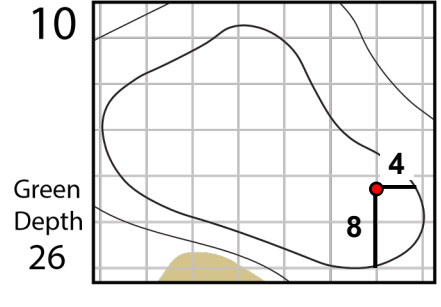
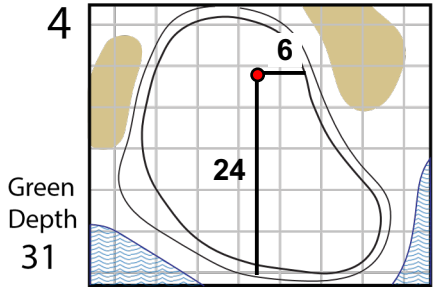
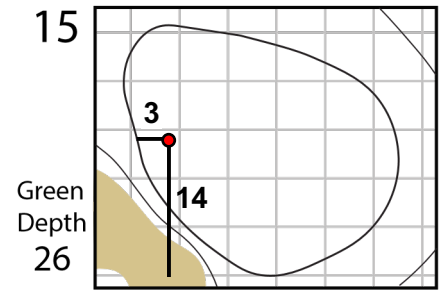
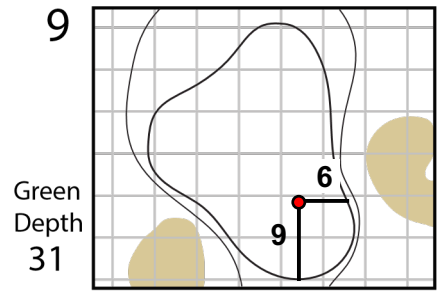
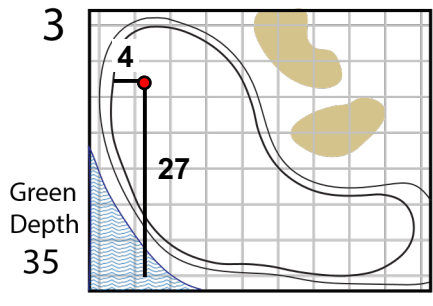
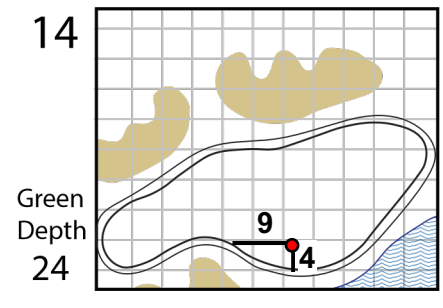
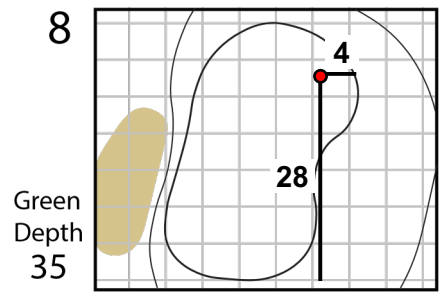
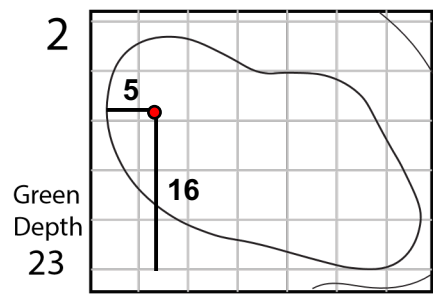
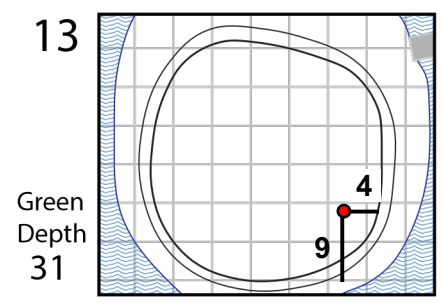
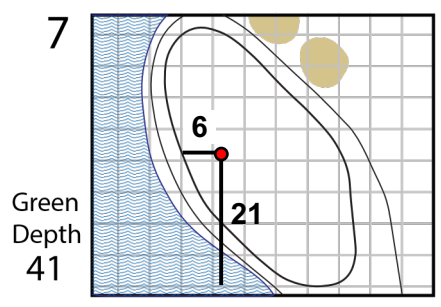
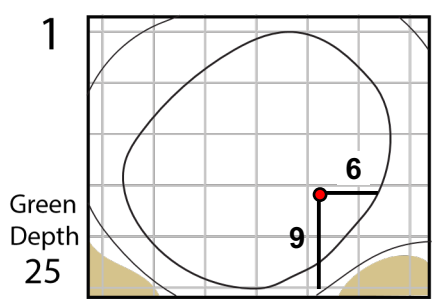

⊕ Location in yardage book from which the green illustration is drawn and measured.